

AM8 Printer

A metal frame for your Anet A8

By Pheneeny
v1.0 April 20, 2017

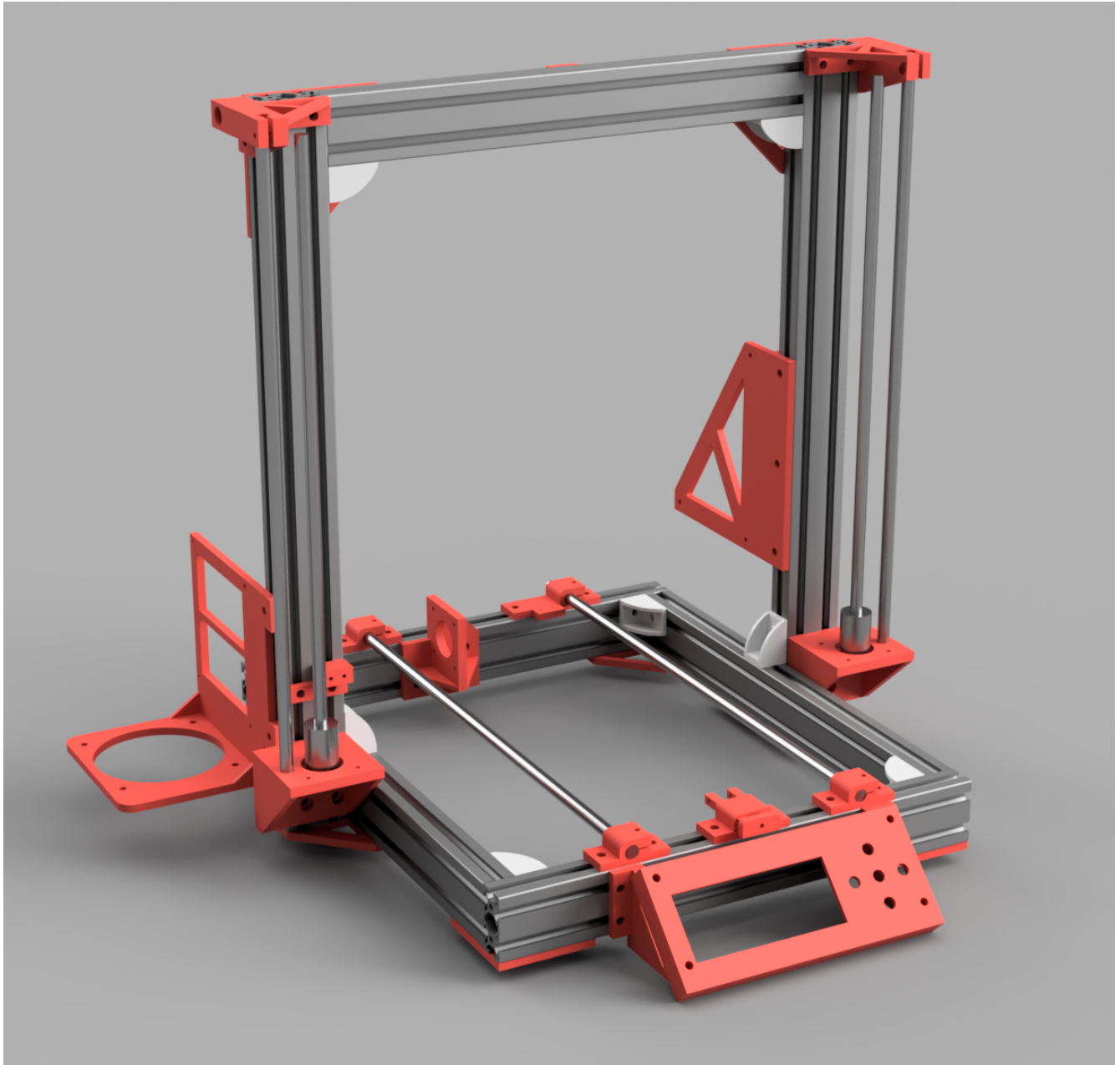

Please read this entire document
before printing parts or building
this frame

Disclaimer:

This guide is for informational purposes only. Follow this guide at your own risk. This guide is for building an experimental prototype frame for the Anet A8. If you do not have a solid understanding of electronics, electricity, wiring, or how your Anet A8 works, do not undertake this project. By following this guide, you accept any and all risks related to this project, and the author of this guide is not responsible in any way for the outcome of your work.

I have tried my best to accurately document and describe the build process I have followed and the parts I used, but I cannot guarantee the information is 100% accurate or complete.

The build specified here works with my Anet A8 purchased in October of 2016. I cannot guarantee that this frame will work with all Anet A8 printers, as I have no way of knowing if or what they may have changed.

Warning:

The Anet A8 has several design flaws and potentially dangerous issues that are not addressed in this guide. This guide is only intended to help build a sturdier frame for the Anet A8, and does not address any other issues the printer already has. You are still using this printer at your own risk!

Introduction

The goal of this guide is to create a sturdier frame for your Anet A8 printer, re-using as many components from the original printer as possible to reduce the costs of improvement as much as possible.

I have designed this upgraded frame to work with an entirely stock Anet A8. Upgrading and customizing the Anet A8 is extremely popular among it's owners, and there is no way I could cover all of the mods that exists for this printer. By sticking to how the Anet A8 is supposed to be built out of the box, I'm hoping to reach as wide of an audience as possible. Many modifications and upgrade for the original printer will still be useful and compatible with this new frame.

I highly advise against building a new frame for your A8 if you do not already have another working 3D printer. If the A8 is the only 3D printer that you have and you dis-assemble it, it may be impossible to re-print any parts that you lost/forgot to print/ printed wrong. If the A8 is your only printer and you want to continue with this build, please make sure that you have ALL of the parts required before dis-assembling the A8.

The dis-assembly of the A8 is not covered in great detail in this guide, as it is assumed that being able to assemble the A8 means you are also capable of dis-assembling it with little instruction.

Discrepancies

You will probably notice small discrepancies between the renders, the pictures of the built printer, and the instructions. I built this printer with spare parts I had on-hand that by a stroke of luck were very close to optimal, but some of them are a little off. For example, the bottom extrusions running front to back should be 340mm, but I had and used 333mm extrusions, so the renders and the pictures show the Y smooth rod hanging past the Y Rod Holder by about 7mm, which you won't see if you use 340mm extrusions.

Another example is the top cross member should be a 313mm 2040 extrusion, but I used 2x 313mm 2020 extrusions.

The renders also do not show a lot of the parts from the A8, so make sure you read the instructions carefully to know when you should add A8 parts.

Tools

The following tools will be required in order to complete the build of this frame:

1. A working 3d printer (To print new parts)
2. M5x.8 Tap
3. Power drill with assorted drill bits
4. Metric Tape measurer or caliper
5. Set of compatible hex keys / allen wrenches

Anet A8 Parts

We will re-use the following parts from the Anet A8:

1. Motors
2. All smooth rod rails (2 X, 2 Y, 2 Z)
3. Z axis Lead Screws
4. Heated bed and carriage
5. Extruder
6. Hot End
7. Endstops
8. Bearings
9. Belts
10. Controller Board
11. Power Supply
12. LCD
13. Wiring
14. Miscellaneous M3 screws and nuts

Plastic Parts

This frame uses a number of plastic printed parts. These parts are generally used for alignment, with a secondary goal of adding stability. Each frame joint has at least one metal connective component that will primarily handle the stability of the frame. However, some plastic parts, namely the motor mounts and tensioner, are solely responsible for structural integrity of the connection.

I highly recommend printing all plastic parts in a high temperature resistant material, such as ABS or PETG. You may have difficulties with some parts, especially those with close proximity to heat sources like the heated bed, or those under constant tension/stress like the belt tensioner, if they are printed in PLA.

These issues will be even worse if you use this printer for printing high temperature materials, as the bed temperatures required for those materials is much higher.

I recommend printing all parts with at least 40% infill.

I printed the Y Belt tensioner block at 100% infill, and I printed the Y Belt Tensioner bearing carrier at 0.1mm layer heights, because the fit on these two parts is tight and I didn't want to have issues. Everything else I printed with 1.2mm shells, 0.2mm layer height, and 40% infill. All parts were printed without any supports

Depending on the calibration and accuracy of your existing printer, some holes may come out smaller than necessary and require a little drilling using an electric drill to open them up a bit.

It is also very helpful to pre-fit the smooth rods into the plastic pieces. The fit can be very tight, but spinning the plastic piece onto the smooth rod helps move it through the hole. It is easier to loosen these holes in the plastic pieces before assembling.

The STL files have a number at the front of their name, such as 3_Y_Rod_Holder.stl. The number indicates how many of this printed part you need, in this case you would need 3 copies of this part.

Tap The Extrusions

Using the M5x.8 tap, you will need to tap the two holes on one end of each 440mm extrusion. Each 2040 extrusions has two holes on each end, and the end of the extrusion that will be on the bottom requires both holes be tapped with an M5 thread before assembling.

Purchased Parts

All purchased parts can be found in the separate BOM spreadsheet. I have listed essential parts, with the required quantity, costs that I was able to find them for, and links to where they can be purchased. Prices and availability are subject to change, and you may not be able to find the exact parts, at the same price, from the same retailers. I will try to keep the BOM updated as availability changes, but you may have to find alternatives on your own.

The BOM also lists optional but recommended parts. These parts aren't necessary for the conversion, but improve the printer.

Dis-assembly

If you were able to successfully assemble the A8, you can successfully take it apart. I'll briefly discuss how to take it apart and what you can keep together.

This is a great time to clean and lubricate the moving parts of the printer. I cleaned the smooth rod and lead screws with hot water and dish soap, then applied a small amount of sewing machine oil to lubricate them. I'm not sure how helpful the oil was on the smooth rod, as it pooled up a bit at the bearings and needed to be wiped away, but it is very helpful on the lead screws.

1. REMOVE POWER FROM THE PRINTER! Unplug the printer before you do anything.
2. Seriously, make sure the printer is unplugged from the outlet!
3. I disconnected everything from the controller board. Remove the plugs for all motors, endstops, power, bed, and hotend.
4. Unhook the power cable from the back of the bed.
5. Remove the belt pulley and the two 8mm nuts from the front of the threaded rods at the base of the A8. This will allow you to pull the front acrylic piece off and remove the entire bed/carriage/rods. The rods can be pulled out and cleaned.
6. Remove extruder hotend/extruder/motor assembly and set it somewhere where there isn't any tension on the wires. This can be removed by removing the hex set screw on the bottom of the carriage, and loosening the nut on the heat break. If all of the wires are disconnected from the controller board, you should be able to completely remove the hotend and set it aside.
7. Loosen the bottom set screws on the Z axis flex couplers, allowing them to be removed from the motors.
8. Remove the two acrylic frame pieces from the top that hold the top of the Z axis rods.
9. Once the corner pieces are removed, you should be able to remove the entire Z and X axis in once piece, including all rods, lead screws, motors, belt, everything.
10. Remove the remaining motors and endstops that are still connected to the frame.
11. Unscrew the 4 screws that hold the LCD in place.
12. Keep track of any screws and nuts that you remove as we will re-use some of these later.

All that should be left of your A8 at this point is the mostly in-tact acrylic frame.

Assembly

It's time to start assembling the new printer. All of the components will be attached using M5x10 screws and M5 square nuts. Most pieces will be assembled by placing the screw through the component and lightly threading a square nut onto it, then sliding the square nut into the extrusion channel.

Assemble bottom frame sides

Each frame side will require the following:

- 1x 340mm extrusions
- 2x Printed Bottom corner plates
- 5x Aluminum corner brackets
- 1x Printed Bottom tee plates
- 22x M5x10 Button Head Screws
- 2x M5x16 Socket Head Screw
- 24x M5 Square Nuts
- 2x Rubber Feet

1. Place an M5x10 button screw through every hole of each component (except for the middle holes of the bottom corner bracket, and the outside holes of the Tee bracket, which will be filled later) and lightly thread an M5 square nut onto each piece.
2. The middle screw of each corner plate should be a M5x16 socket head screw with a rubber foot between the head of the screw and the plastic piece.
3. Slide all of the components into position, starting with components that sit in the middle of the extrusion. The bottom tee bracket, and the three aluminum corner brackets that sit in the middle of the extrusion should be left loose to allow easy position adjustment later.
4. Align the face of the aluminum corner brackets with the end of the extrusion and tighten the screw to keep it firmly in place.
5. Align the corner plates so that there is room for the front and back extrusions to fit snugly against the side extrusions.

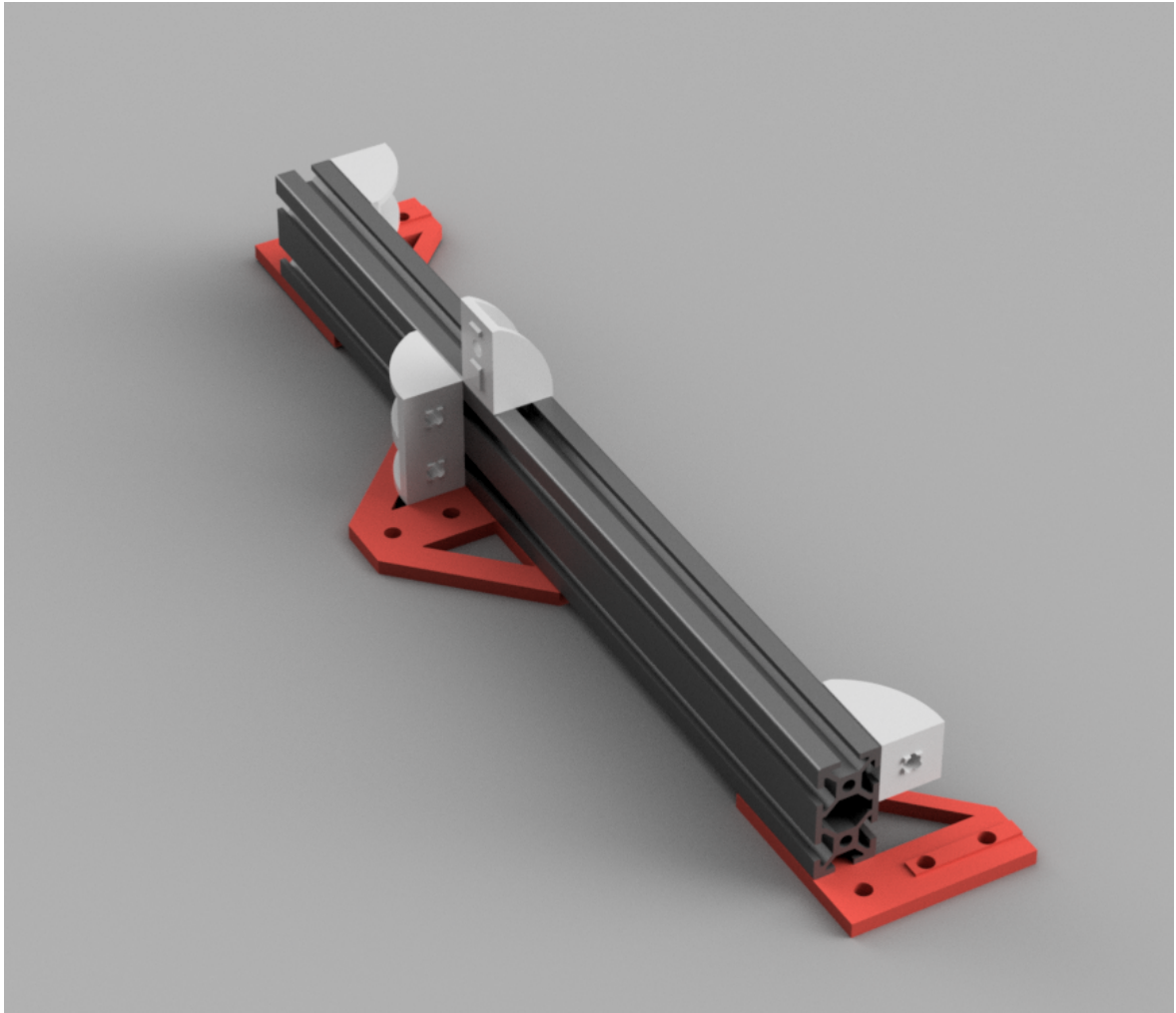

Your left frame side should look like this:

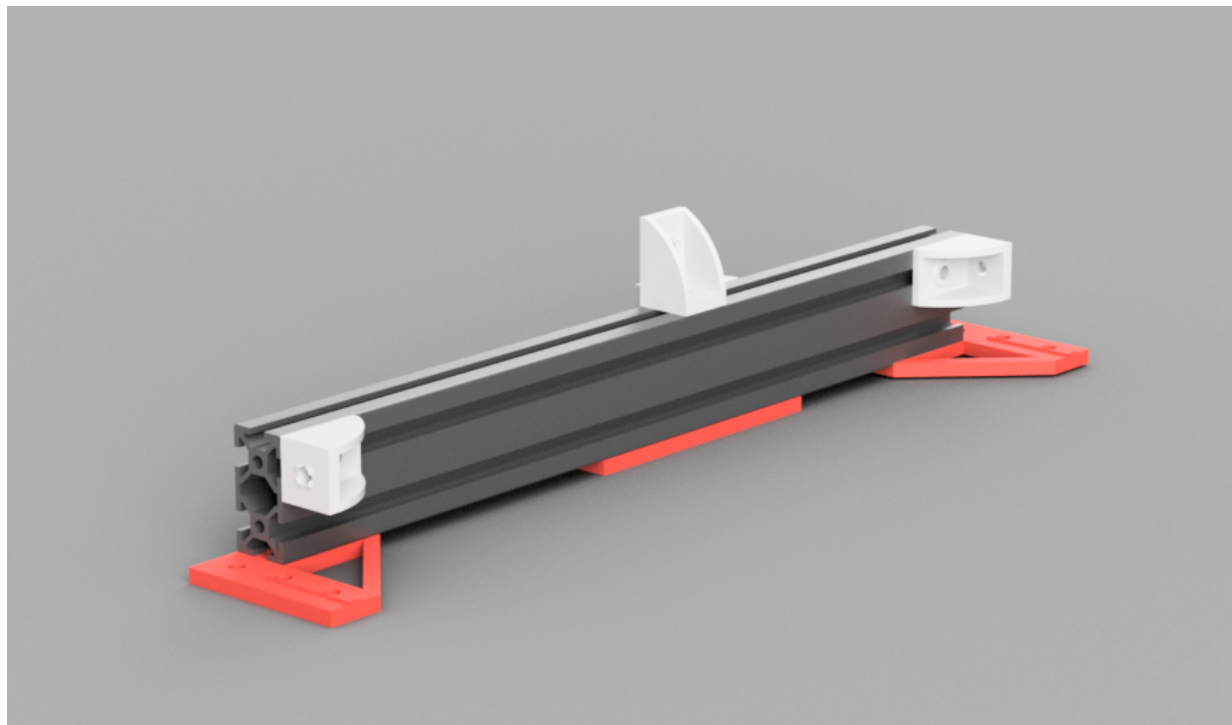

Assemble the right frame bottom using the same components as the left, but component orientation will be as follows:

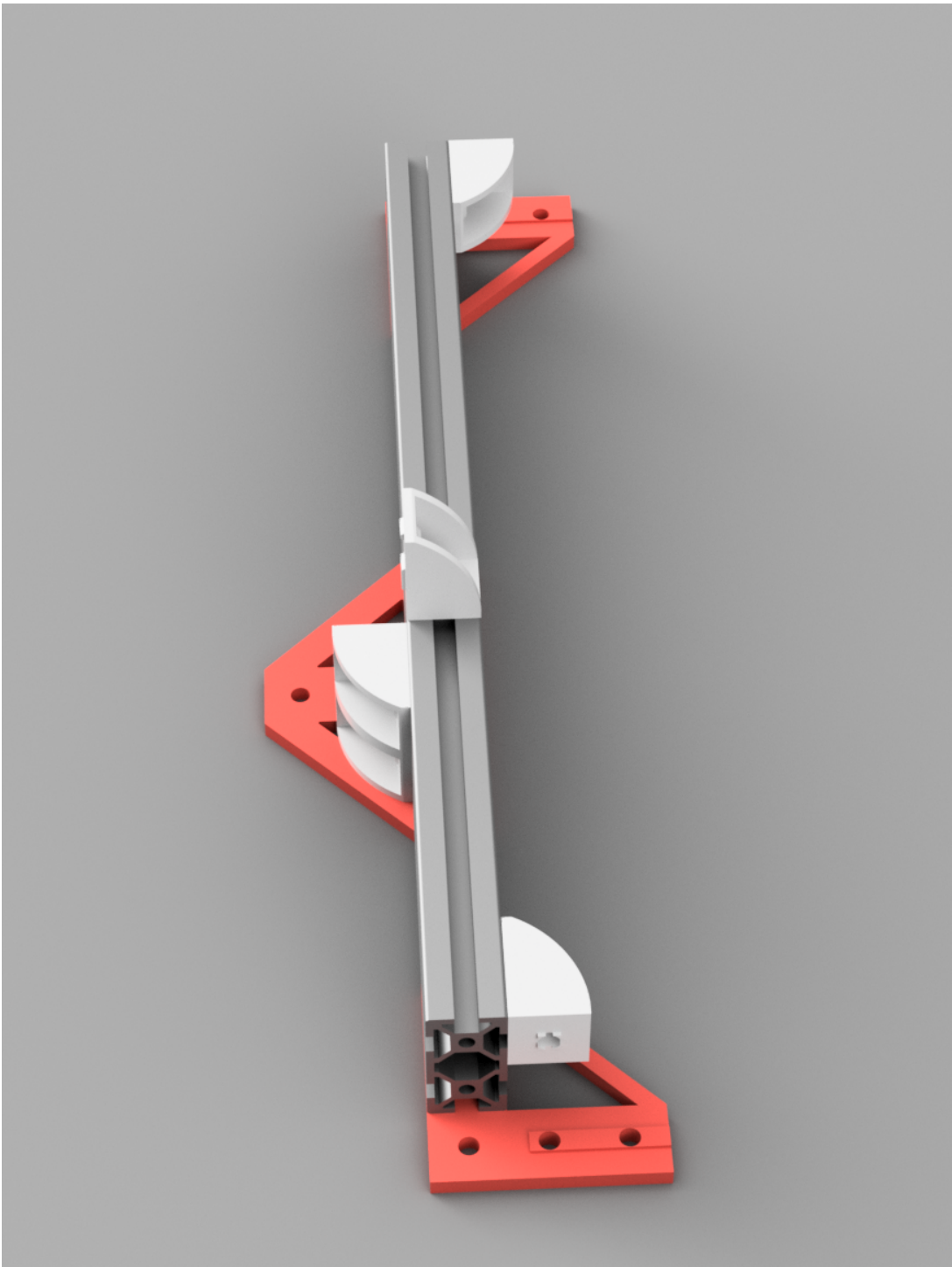

When you are finished, you should have two components that look like this:

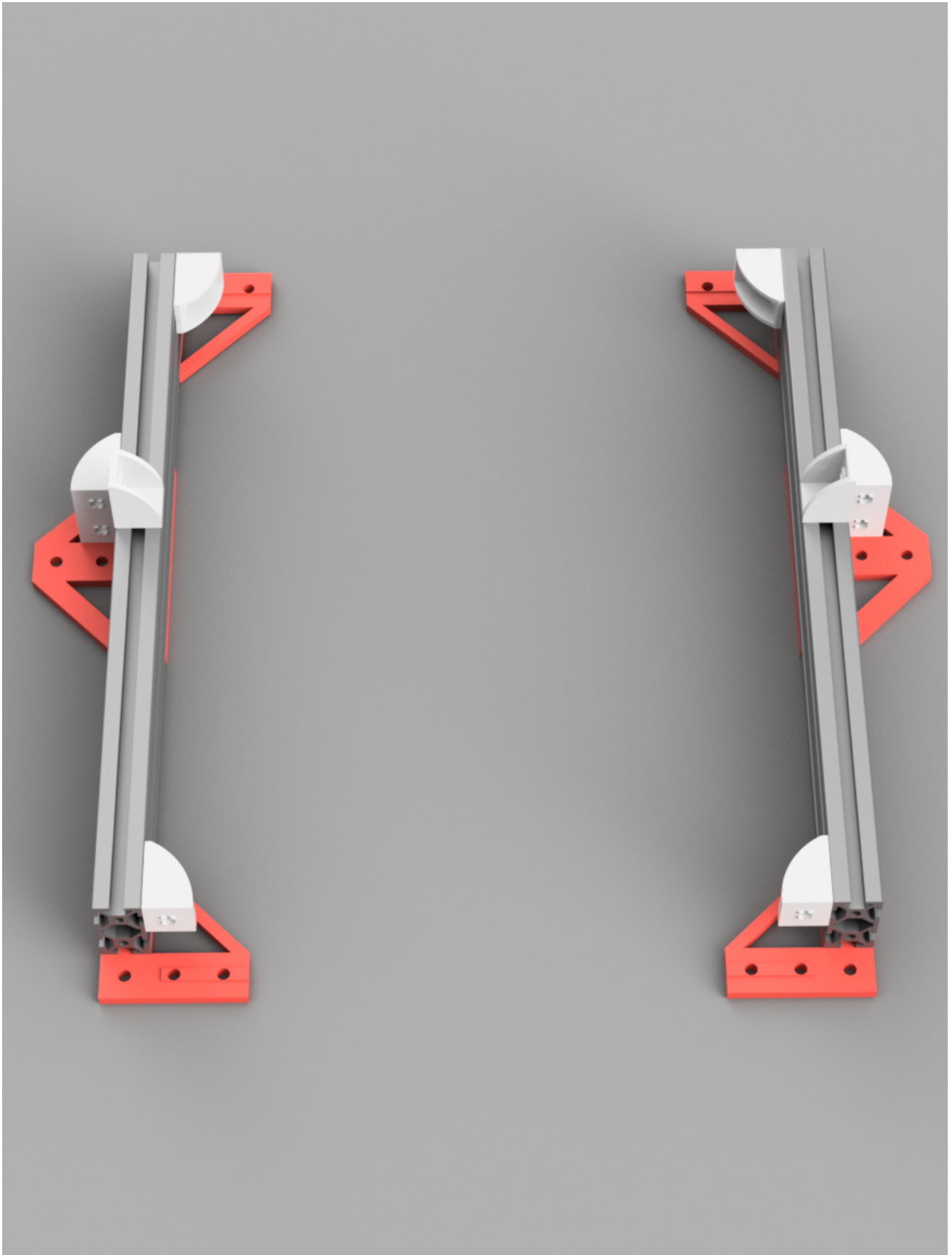

Set aside the right frame bottom for the time being.

Front and Back Extrusions

Parts Needed:

2x 313mm Extrusions

1. Slide a 313mm Extrusions onto both the front and back corner plates. You will need to make sure the square nuts are entering the extrusion channel at the proper angle or they will not slide in. Make sure the extrusions meet the side frame at a right angle, and the end of the 313mm extrusion is aligned with the outside edge of the right frame extrusion, as shown in the illustration below.
2. Once aligned, tighten any loose screws connecting the 3 extrusions.

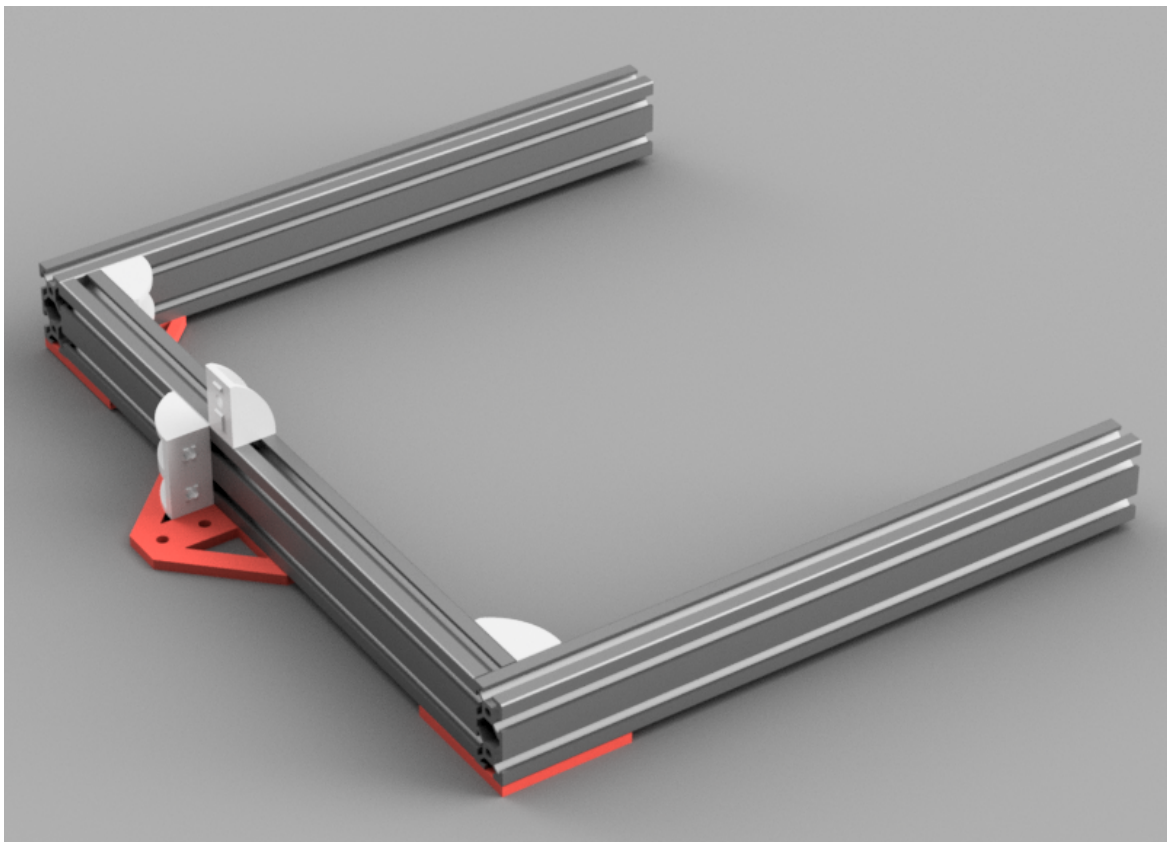

Mount Y Rod and Bed

Parts Needed:

- 1x 380mm Smooth Rod
- 2x Y Rod Holders (Printed)
- 4x M5x10 Button Head screws
- 4x M5 square nuts
- 2x M3x18 screw (From A8)
- 2x M3 hex nut
- 1x Heated bed and carriage

1. Place 1x Y Rod Holders onto the smooth rod. The ends of the smooth rod should line up with the outside edge of the plastic pieces.
2. Slide Heated Bed bearing onto smooth rod. Make sure the power connector of the bed is facing the rear of the printer (The image below is looking at the front of the printer).
3. Slide other Y Rod Holder onto open end of smooth rod.
4. Lightly thread M3 screw into the clamping mechanism on both Y rod holders. Place M3 hex nut into the hex hole.
5. Tighten the M3 screw until it holds the hex nut in the hex hole firmly enough that it can't fall out, but applies no pressure to the clamp.
6. Slide Y Rod Holders on to front and back extrusions, but do not tighten yet. Leave these loose for alignment later.

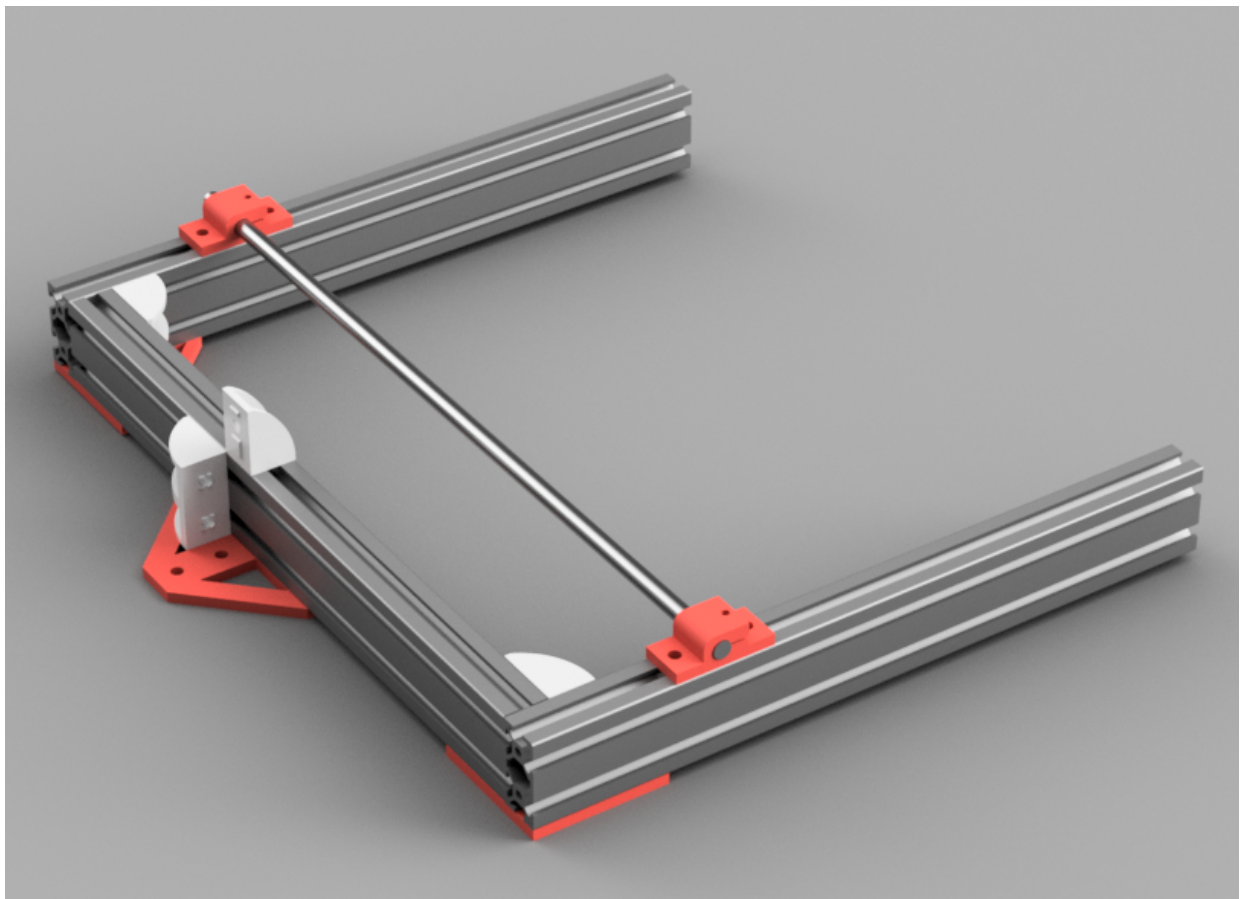

Mount Y Motor and Tensioner

Parts Needed:

- 1x Y Motor Mount (Printed)
- 1x Y Motor
- 1x Y Belt Block (Printed)
- 1x Y Belt Tensioner (Printed)
- 5x M5x10 Button Head screws
- 5x M5 Square Nut
- 1x M3x10 screw
- 5x M3x20 screw
- 4x M3 washer
- 2x M3 hex nut
- 1x Y Belt Pulley (From A8)

1. Attach Y Motor to Y Motor mount using 4x M3x20 screws, each with a washer between the screw head and mount.
2. Slide Y motor mount onto rear extrusion. Leave loose for alignment later.
3. Slide tensioner block onto front extrusion.
4. Place M3 hex nut into hex hole on tensioner
5. Thread M3x10 screw into tensioner, just tight enough to hold hex nut in place.
6. Slide tensioner into tensioner block.
7. Attach belt pulley to Y tensioner with M3x20 screw and hex nut.
8. Leave all screws loose for alignment later.

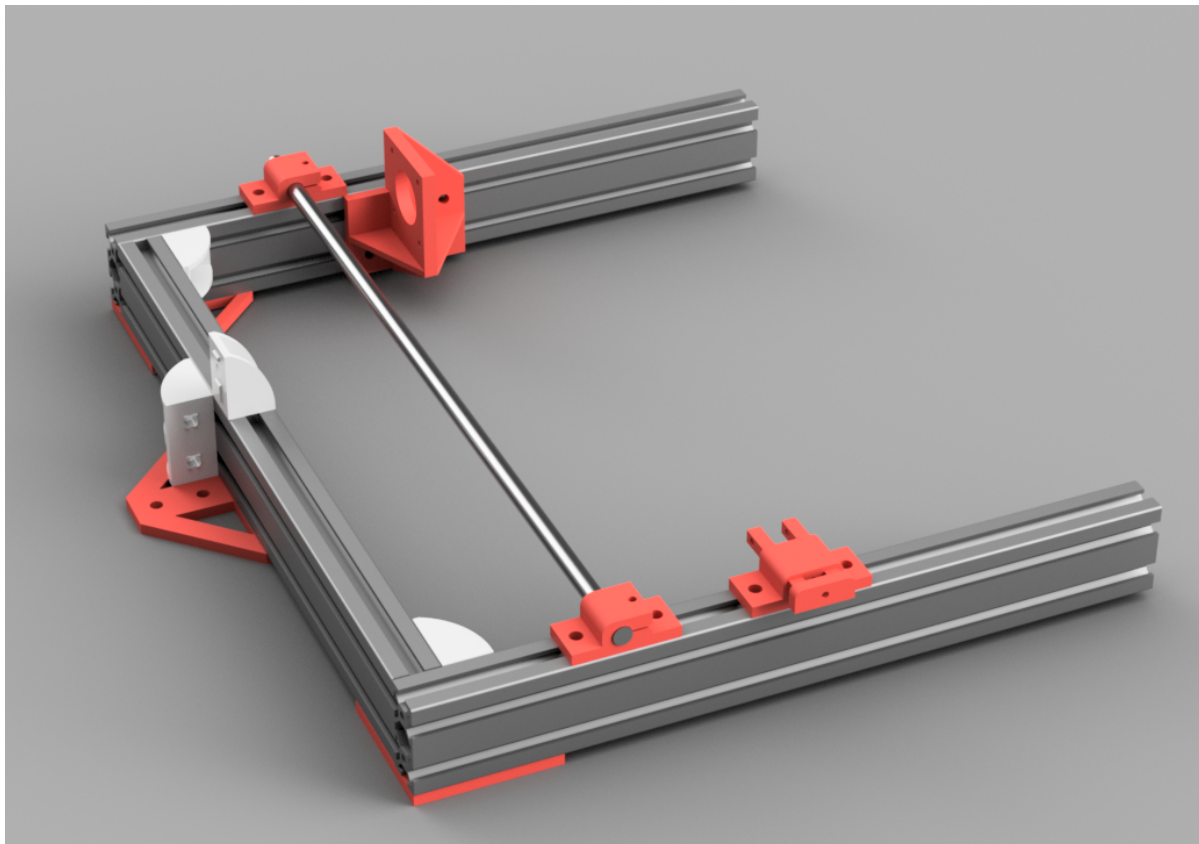

Mount Remaining Y Rail

Parts Needed:

- 1x 380mm Smooth Rod
- 1x Y Rod Holder (Printed)
- 1x Y Rod Holder with Endstop (Printed)
- 4x M5x10 Button Head screws
- 4x M5 square nuts
- 2x M3x18 screw (From A8)
- 2x M3 hex nut
- 1x Y Endstop (From A8)
- 2x Endstop Screws (From A8)

1. Slide Y Rod holder with endstop onto the back extrusion.
2. Slide 380mm Smooth Rod through the bearings in the bed carriage and into the Y Rod holder already installed. Press the rod through the rear rod holder further than necessary to make room for the front rod holder.
3. Slide front rod holder onto extrusions.
4. Press rod through front rod holder until it is flush at the front.
5. Tighten the rod holder tension screws when you are happy with the placement of the rods in the rod holders.
6. Leave the M5 screws of the rod holders loose for alignment later.
7. Attach the Y Endstop to the rod holder mount using the original endstop screws.

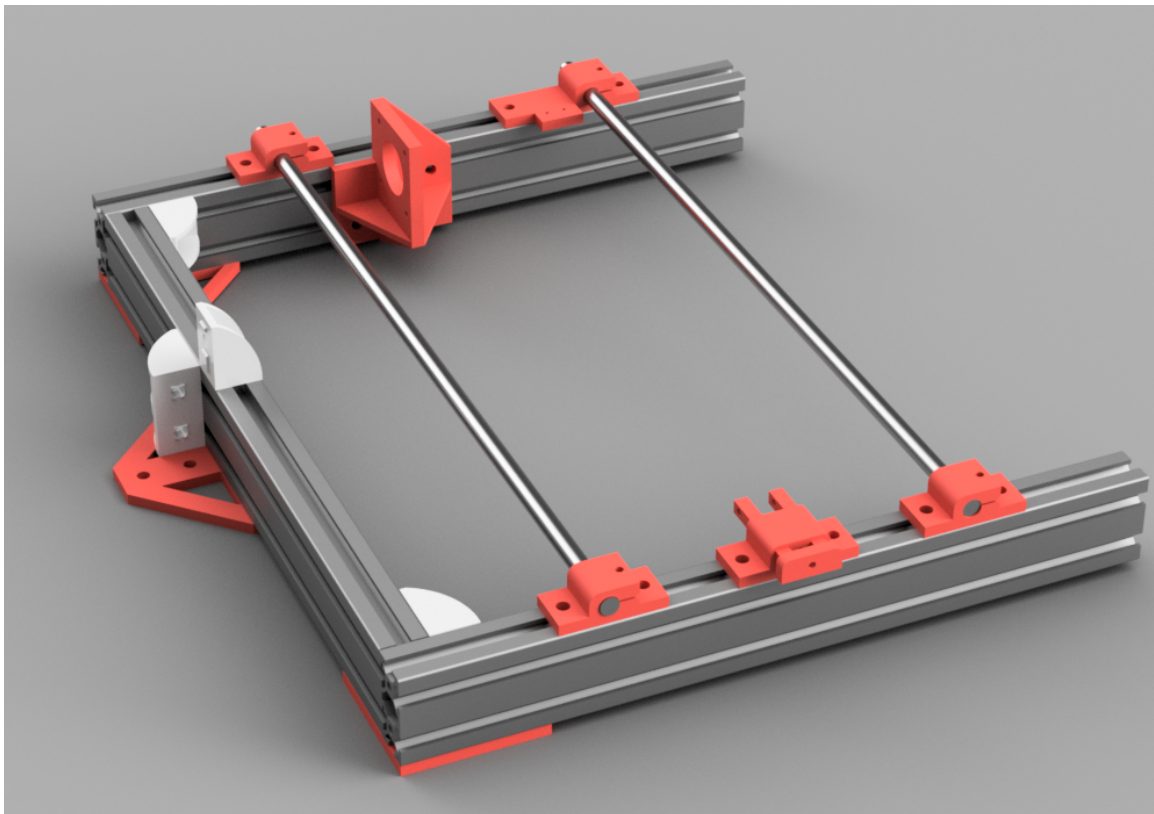

Attach Right Side Frame Bottom

Parts Needed:

1x Right side frame bottom assembled in previous step.

1. Slide the assembled right side frame bottom onto the rest of the bottom frame. It can be tricky to get all of the square nuts lined up properly.
2. Now that the frame is assembled and tightened, align the Y Rods on the front and rear extrusions. The rods should be centered on the extrusions, and most importantly, the front and back rod holders need to be aligned straight. On my build, the distance from the outside edge of the extrusions to the outside edge of the smooth rod was 69mm.
3. Align the belt tensioner with the belt mount on the bed. Once the tensioner is aligned, tighten the screws to secure it in place.
4. Align the Y motor pulley with the belt mount on the bed. You need to make sure the motor mount is aligned far enough to the left to avoid clipping the heated bed's power connector.
5. I had to loosen the Y motor pulley and move it towards the end of the Y motor shaft to allow the belt to align straight with the bed while avoiding the motor mount from hitting the bed connection.
6. When the motor pulley, heated bed, and tensioner pulleys all align to allow the belt to be straight and the bed moves freely without issue, tighten the belt by tightening the tensioner screw at the front of the belt tensioner.

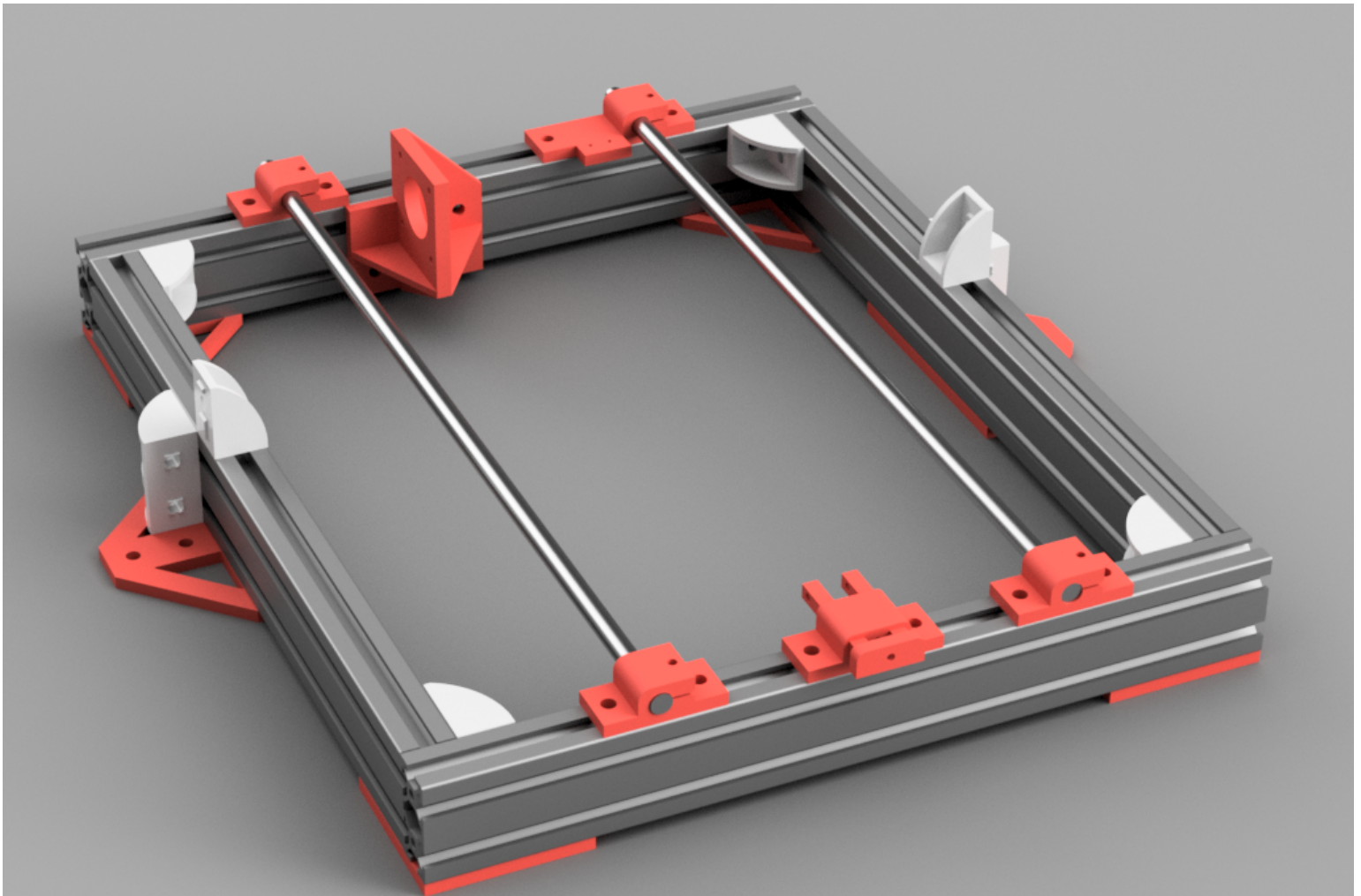

Attach Vertical Extrusions

Parts Needed:

2x 440mm Extrusions with holes tapped

2x M5x10 Button Head Screw

2x M5x16 Socket Head Screw

2x Rubber Feet

1. Slide a 440mm extrusion onto each side of the bottom frame TAPPED END DOWN. Make sure to align all of the square nuts that must slide into the channels.
2. Slide the bottom Tee bracket to align with the bottom of the vertical extrusions.
3. Attach an M5x10 button head screw to the interior tapped hole through the tee bracket.
4. Attach an M5x16 socket head screw to the exterior tapped hole through the tee bracket, with a rubber foot between the screw head and the plastic tee bracket.
5. Tighten all screws attached directly to the vertical extrusions.
6. Before tightening the screws attached to the frame bottom, you need to position the vertical extrusions on the bottom frame. The back edge of the vertical 440mm extrusion should be 127mm from the back edge of the rear extrusion of the bottom frame. The most important part about positioning the vertical extrusion is ensure both extrusions are aligned, and equal distance from the back of the bottom frame.
7. Once the vertical extrusions are aligned, tighten the rest of the screws.

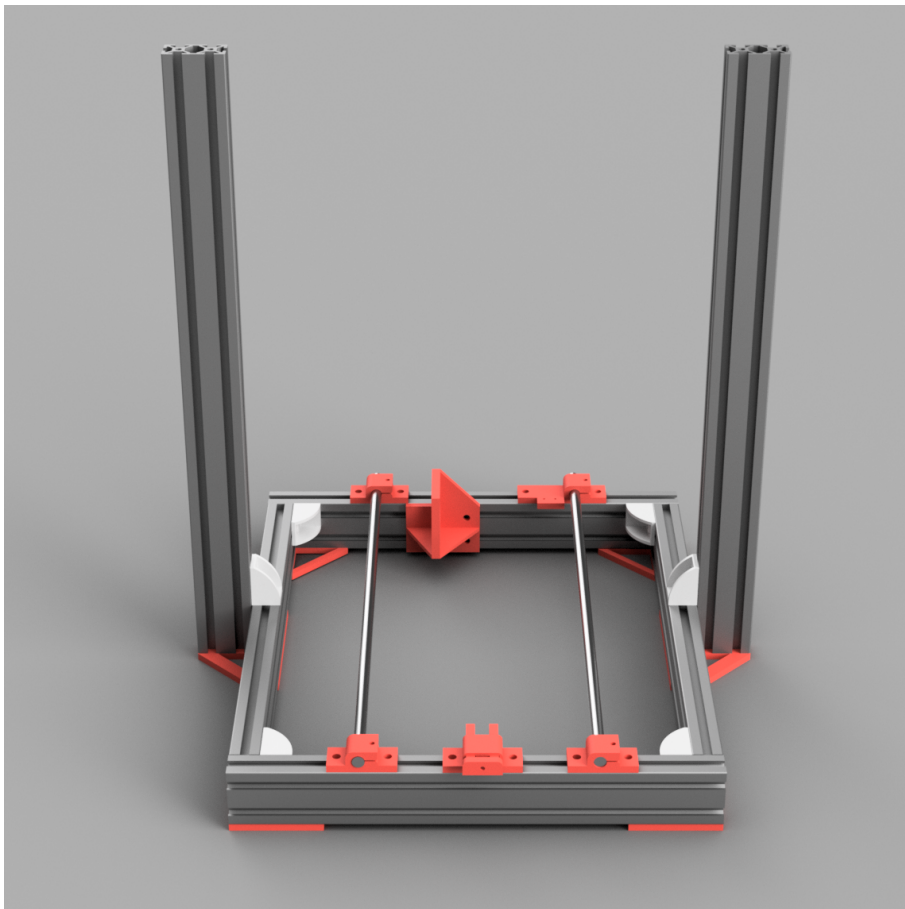

Mount Controller Board Mount and PSU Mount

Parts Needed:

1x Anet Board Mount (Either With or Without Fan Mount) (Printed)

1x PSU Mount (Printed)

7x M5x10 Button Head Screw

7x M5 Square Nut

OPTIONAL With Fan Mount

1x 80mm Fan

2x 80mm Fan Guard

8x M3x20 screws

8x M3 nuts

1. If using a fan, it is easier to mount the fan to the mount before mounting the board mount to the frame.
2. Attach fan to board mount and fan guards on the top and bottom of the fan using the M3x20 screws and nuts.
3. Attach the controller mount to the outside 20mm side of the vertical extrusions and lower to near the bottom of the extrusion, the lower the better.
4. Attach the PSU mount to the right vertical extrusion as shown.

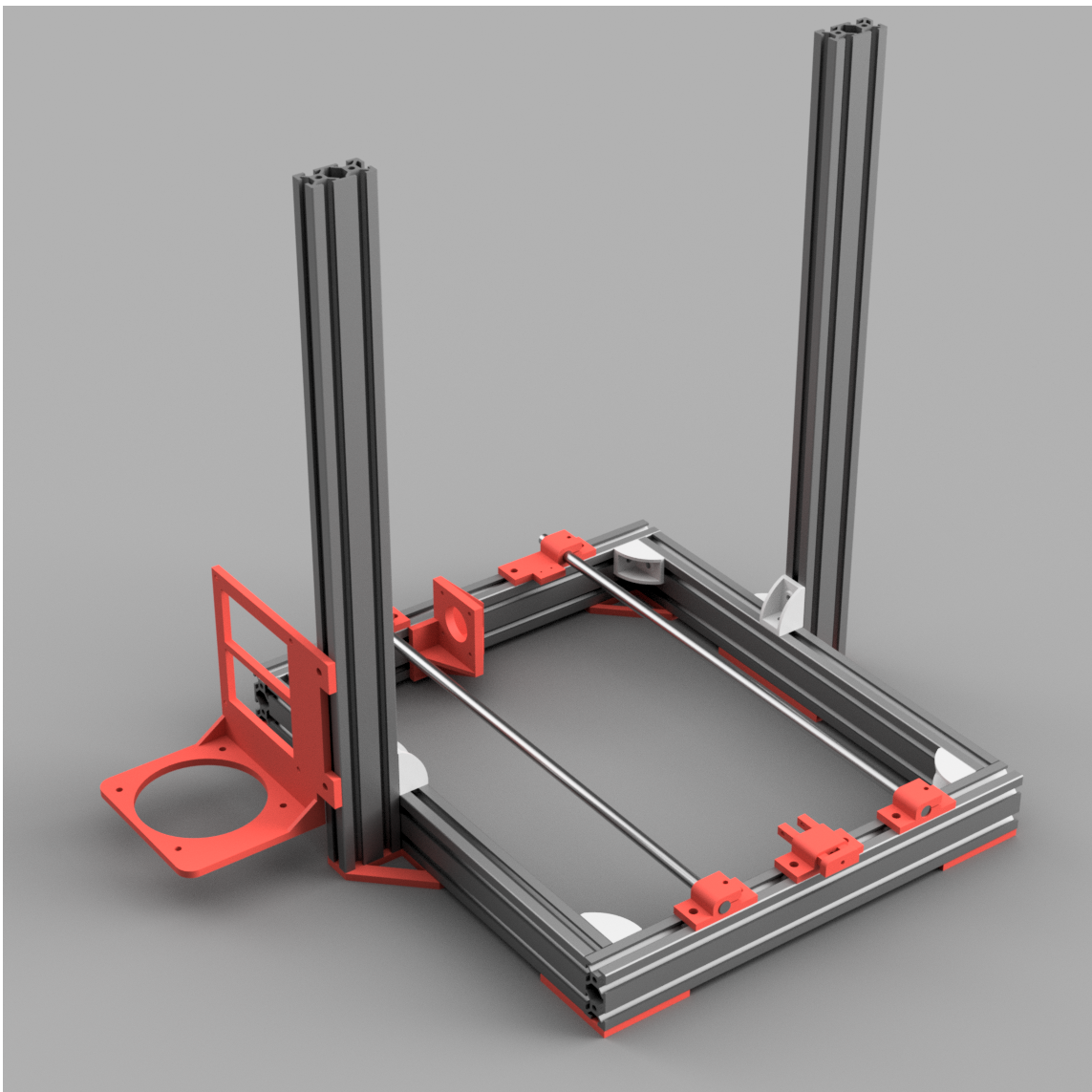

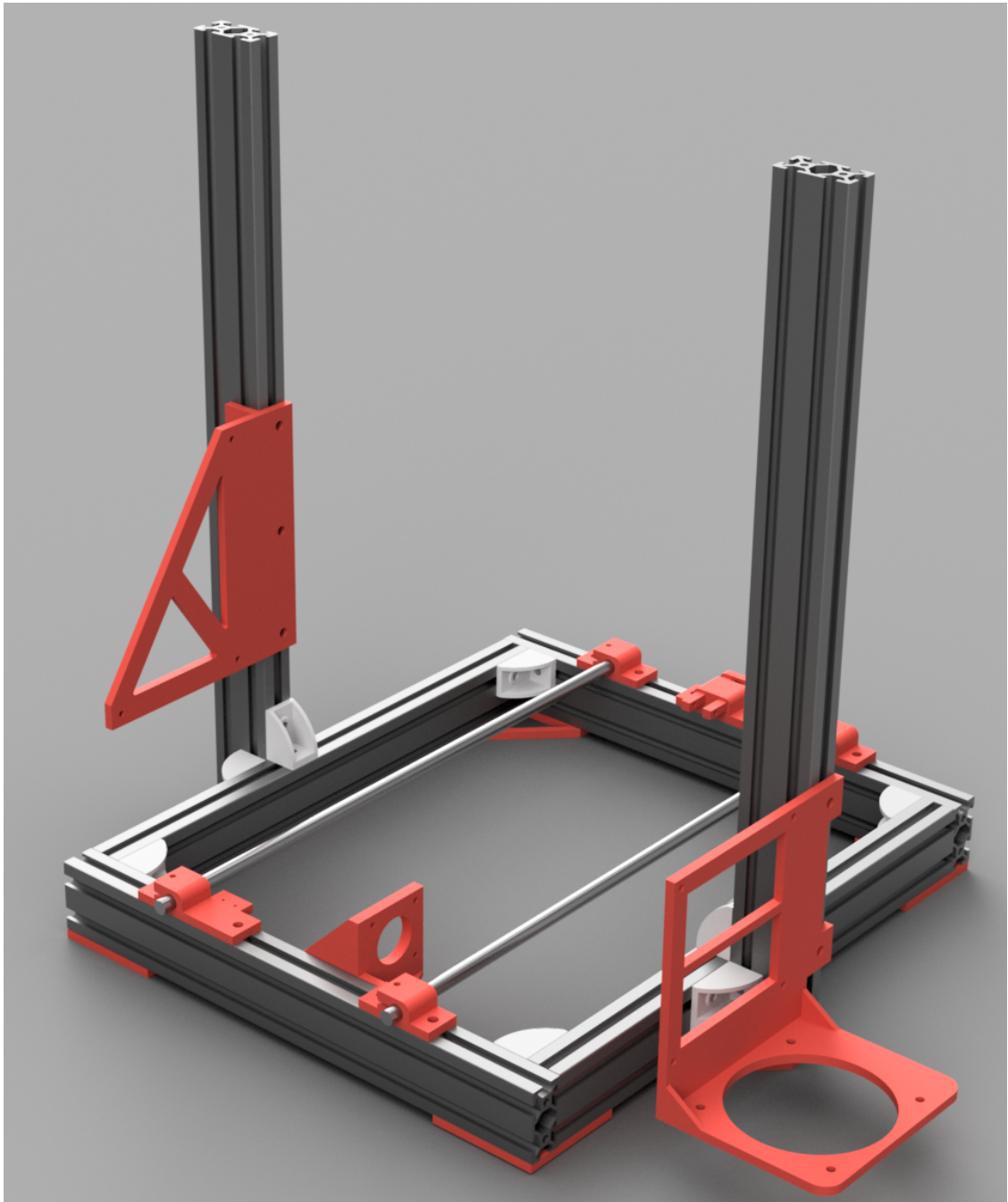

Attach Z Motor Mounts and Motors

Parts Needed:

8x M5x10 Socket Cap Screw
8x M5 Nuts
2x Stepper Motors
8x M3x20 screws
8x M3 washers
1x Z Motor Mount Right (Printed)
1x Z Motor Mount Left (Printed)

1. Slide the left motor mount onto the left vertical extrusion and the right motor mount on the right vertical extrusion.
2. Motor mount should be positioned so that the top of the mount is 25mm above the top of the bottom frame extrusion.
3. Tighten motor mount screws before installing motors.
4. Install motors on each mount using the M3 screws. Make sure a washer is placed between the motor mount and each screw head, otherwise the screws will bottom out before securing the motor to the mount.

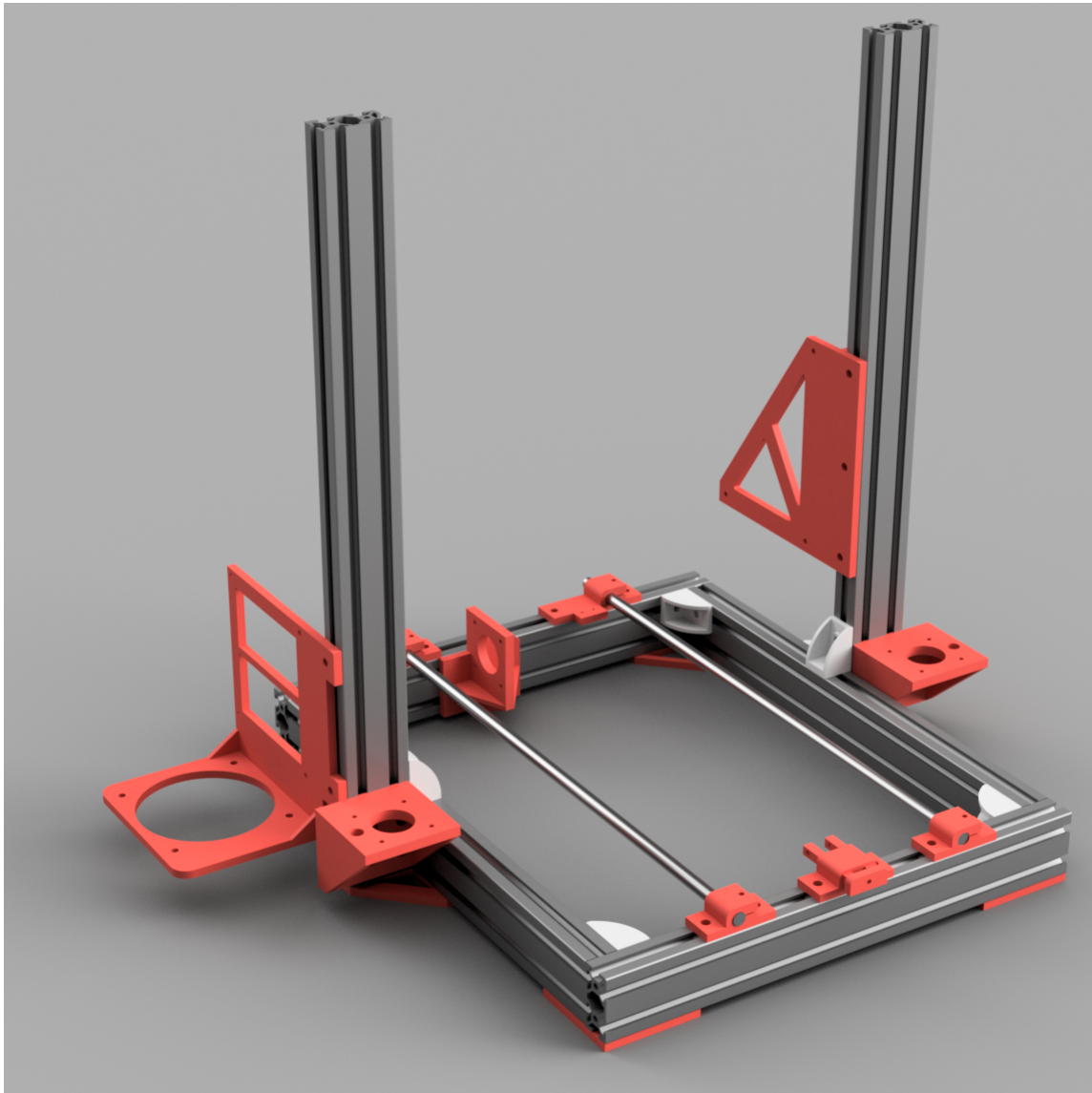

Attach 380mm Rods and Lead Screws

Parts Needed:

2x 380mm Smooth Rods
1x Z Endstop mount (Printed)
1x Z Endstop (From A8)
2x Endstop Screws (From A8)
2x M5x10 Button Head Screws
2x M5 Square Nuts
2x Lead Screws
2x Flexible couplers
1x Assembled X carriage (From A8)

1. Slide Z Endstop mount down the front of the left vertical extrusion, and tighten the screws when the mount is close to the Z Motor mount.
2. Attach the Z endstop to the endstop mount using the original screws from the A8.
3. Attach flexible couplers to the Z motor shafts.
4. Attach Lead screws to each flexible coupler
5. Press the smooth rods into the rod holder holes in each of the Z motor mounts.
6. Place the assembled X carriage from the A8 onto the smooth rod and lead screws. Turn the lead screws by hand in order to lower the carriage to a more stable position at the bottom toward the motor mounts.

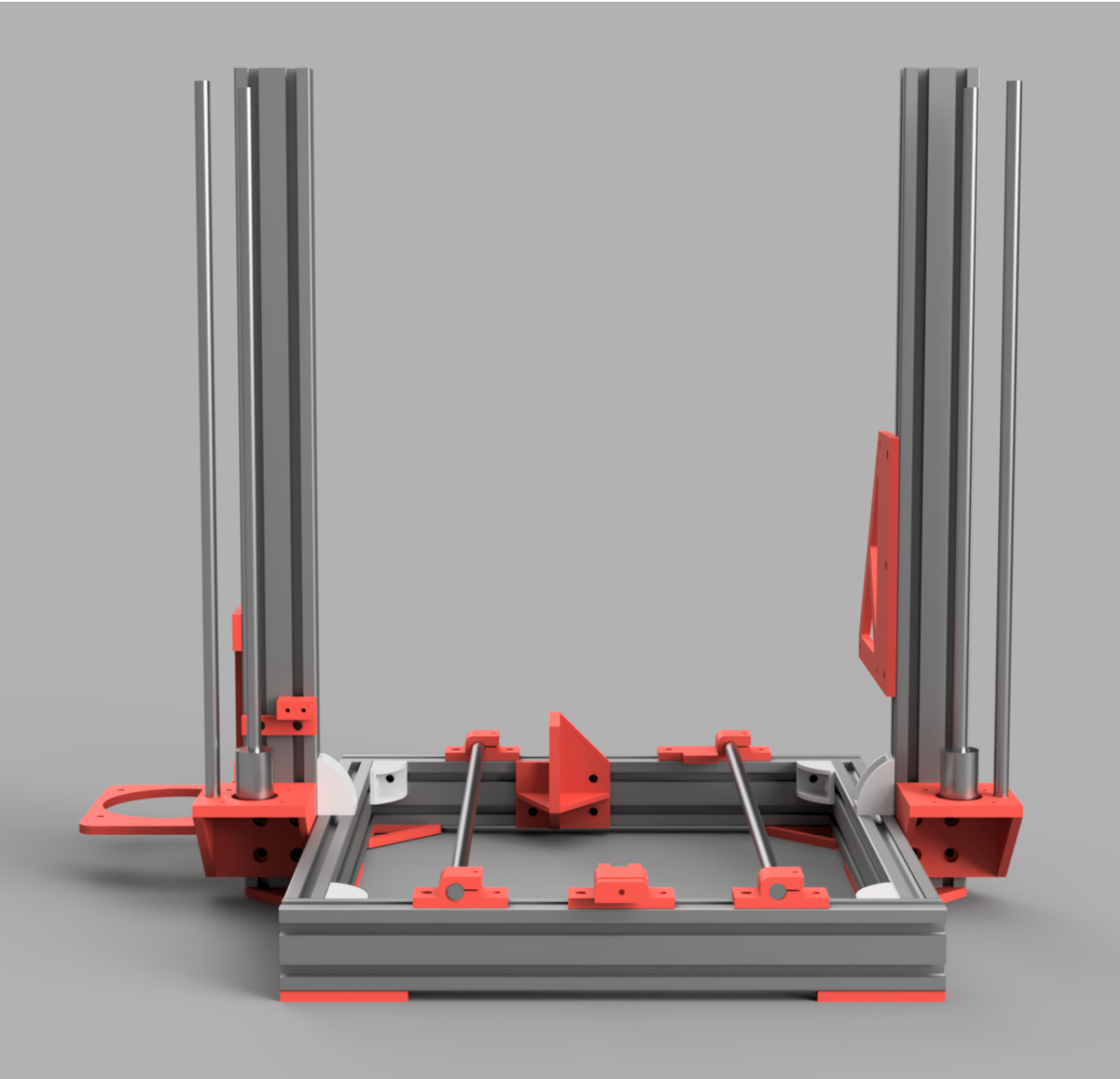

Assemble Z Rod Holders

Parts Needed:

- 1x Z Rod Holder Left (Printed)
- 1x Z Rod Holder Right (Printed)
- 8x M5x10 Button Head Screw
- 8x M5 Square Nut
- 2x M3x20 screw
- 2x M3 Hex Nut

1. Slide Z Rod holders onto extrusions
2. Press rod into Z Rod Holder hole
3. Place M3 hex nut into hex nut holder on each rod older
4. Place M3x20 screw through hole into the hex nut
5. Slide Z Rod holders until they are flush with the top of the extrusions and the smooth rod
6. Tighten M3 screw to clamp onto rods

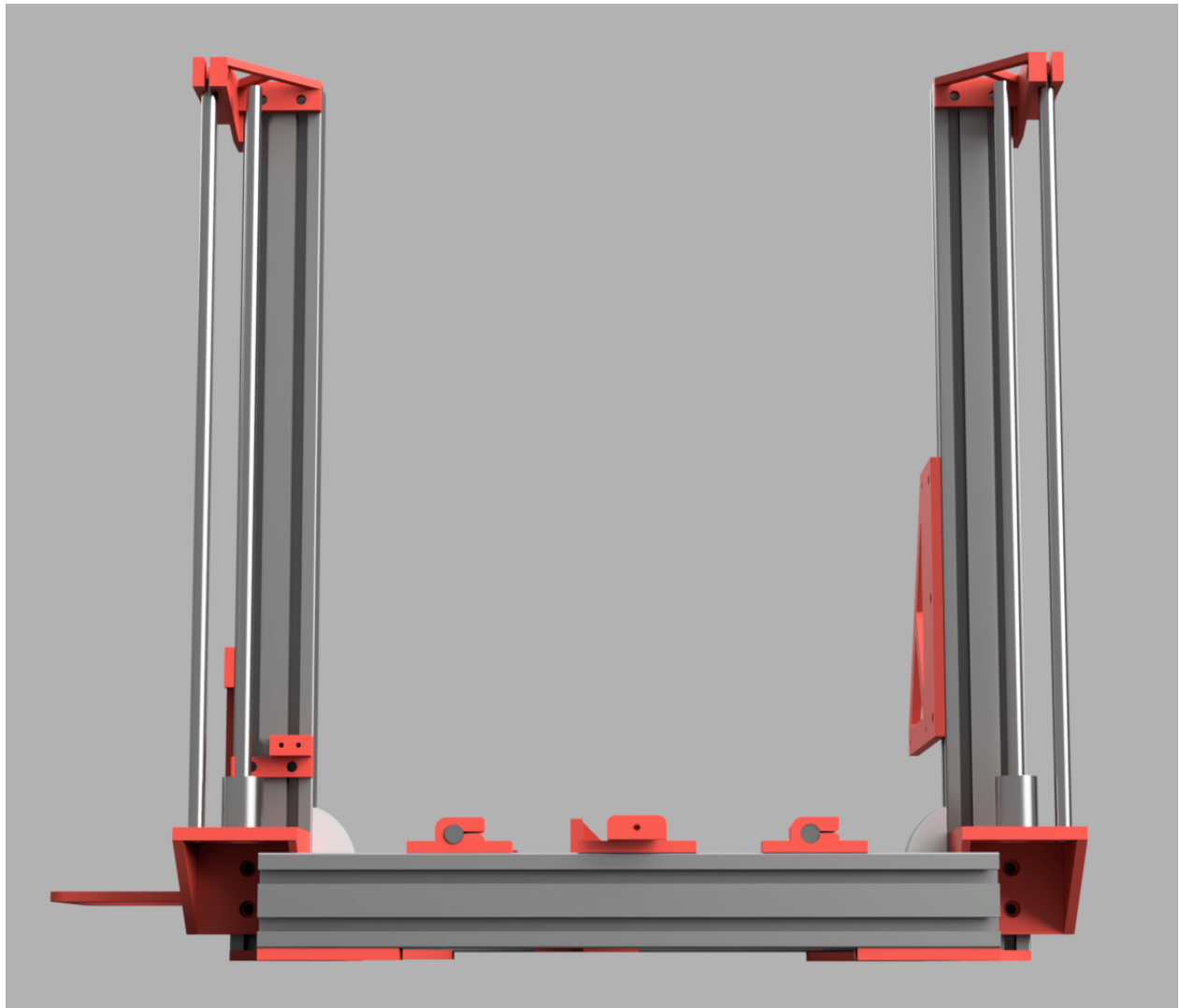

Assemble Top Extrusion Cross Member

Parts Needed:

- 2x Top Corner Plate (Printed)
- 2x Aluminum Corner Brackets
- 1x Wire Holder
- 17x M5x10 Button Head Screw
- 17x M5 Square Nut
- 1x M3x20 screw
- 1x M3 hex nut.
- 1x Wire clamp (From A8).

1. Assemble the components as shown.
2. Attach the wire clamp to the wire holder, but the wires will be run later.
3. Slide the Top Crossmember Assembly onto the vertical extrusions and tighten screws.

Front:

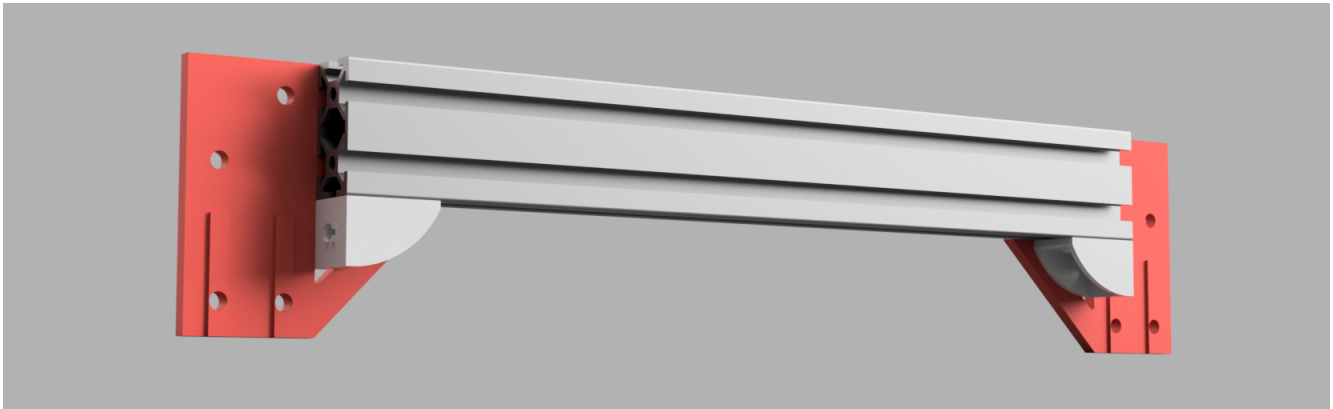

Back:

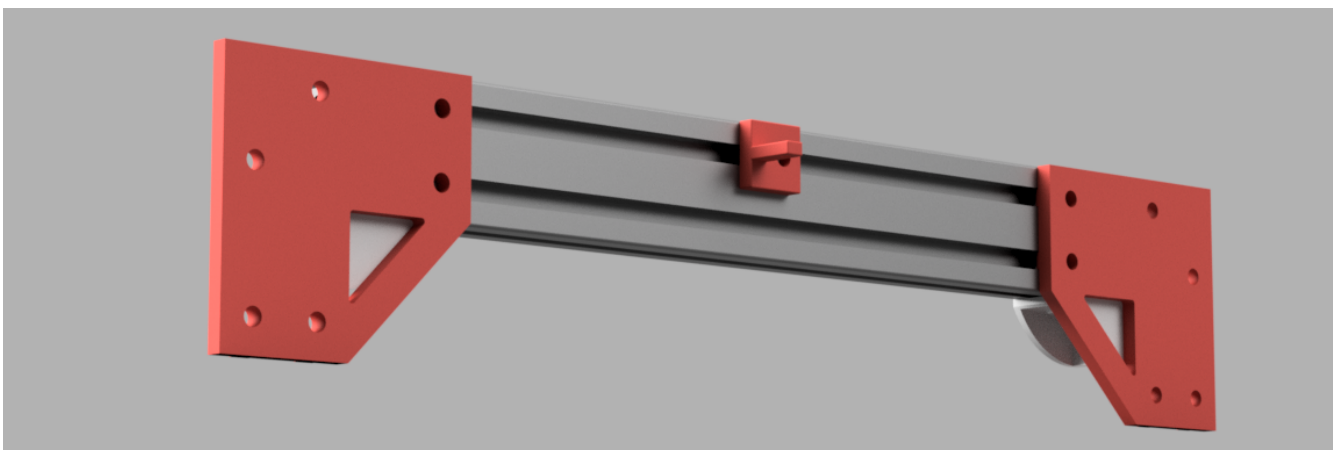

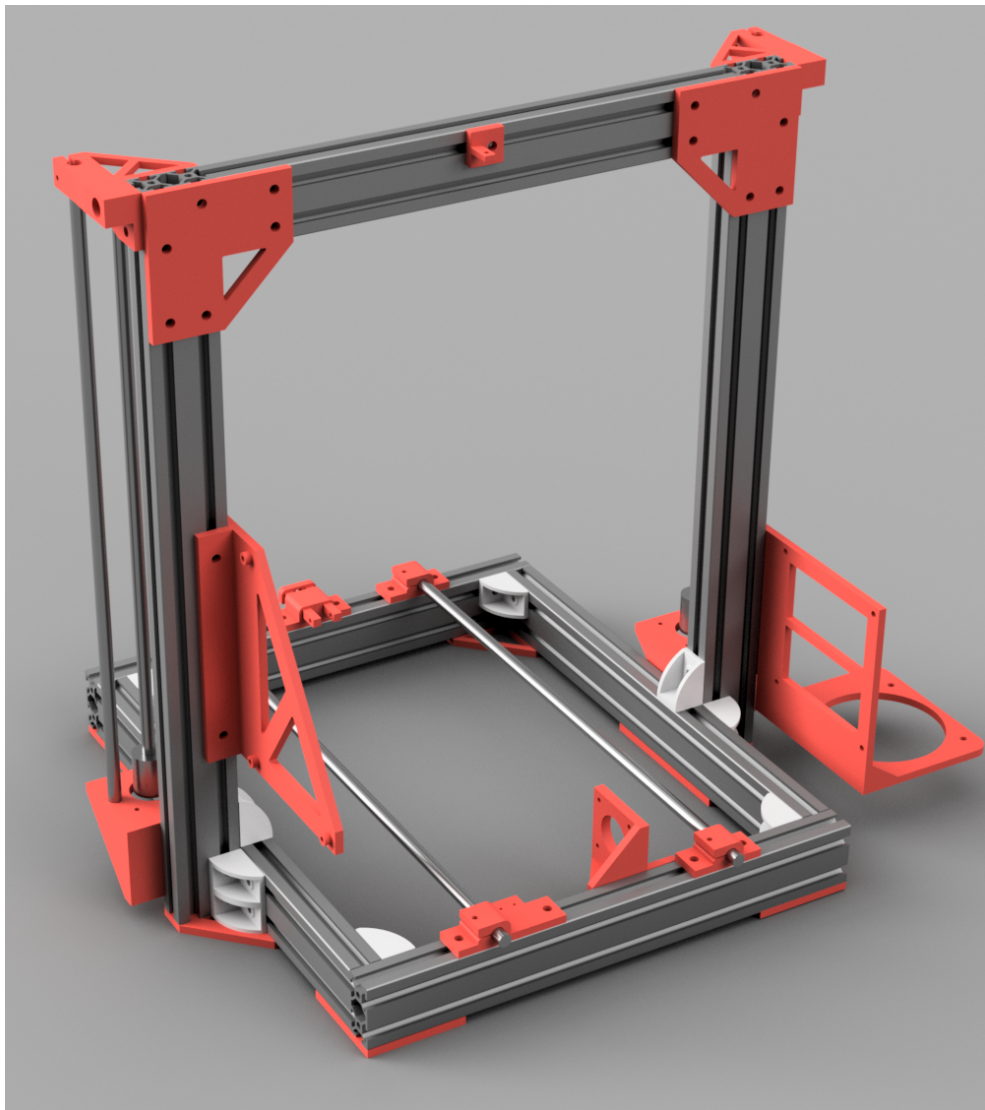

Attach LCD

Parts Needed:

- 1x LCD Case Top (Printed)
- 1x LCD Base Left (Printed)
- 1x LCD Base Right (Printed)
- 1x LCD Screen (From A8)
- 4x M3 LCD Mounting Screws (From A8)
- 4x M3 Hex Nuts (From A8)
- 4x M5x10 Button Head Screws
- 4x M5 Square Nuts

1. Place the LCD Screen into the LCD Case Top. The screen portion should fit snugly in the square hole and sit flush with the flat front of the case.
2. Place M3 hex nuts into the slots in the left and right LCD Base.
3. Thread the original LCD screws through the holes in the LCD Case Top and into the holes in the bases that allow it to screw through the M3 hex nuts.
4. Once the LCD top is secured to the bases, attach it to the front extrusion in the printer base, center it, and tighten the screws.
5. Run the LCD Cable to the controller board. I ran mine under the frame.

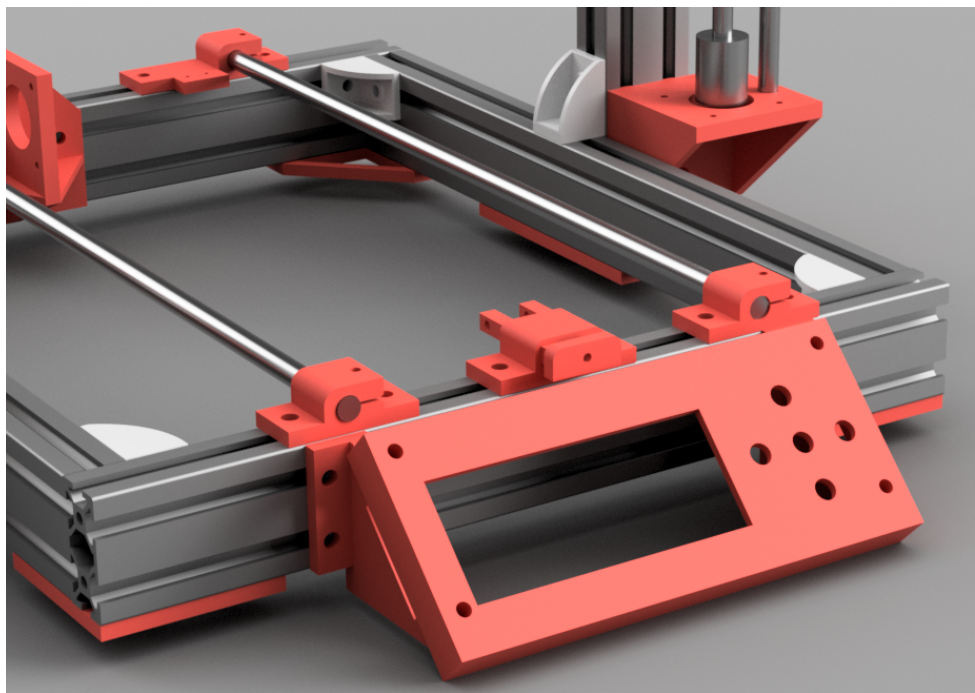
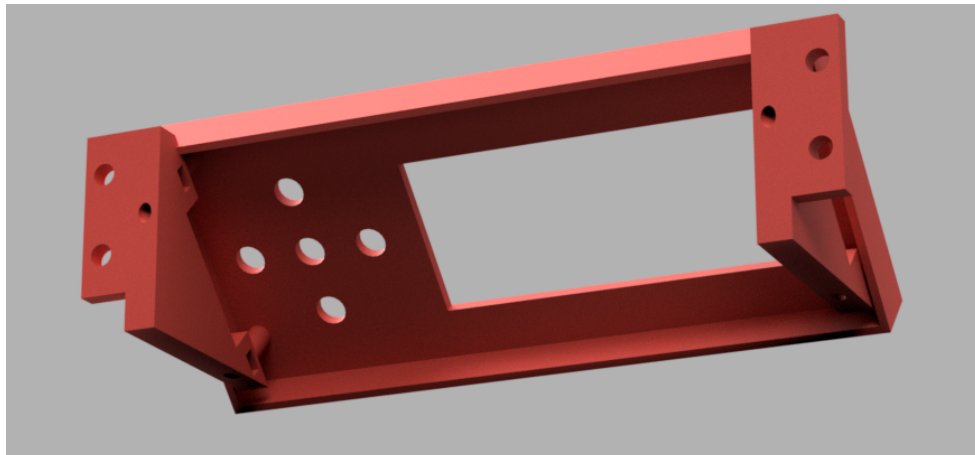

Connect the Controller Board and PSU

Parts Needed:

1x Anet Board V1

1x PSU

Original mounting hardware from A8

1. Use all of the original screws and spacers that were used to mount both the controller board and the PSU.
2. For the PSU, the 3 screws will go through the plastic holes and into the back of the PSU. The PSU should be oriented with the terminal blocks down.
3. The Controller board should be mounted using the original screws and spacers. The spacers should go between the board and the plastic mount.

Run the Wiring

The wires need to be run from the various components to the Anet control board and PSU. Please refer to the original Anet A8 instructions on how to wire the printer to the board and PSU, if you need assistance.

All wires should be reconnected to their original connection points. The path of the wires is your choice. Where possible, I ran wires inside open extrusion channels, and held them in place with printed wire channel clips. If you are running the wires in the channels, make sure that the wires have slack at the ends of the extrusions, ensuring that the sharp edges of the cut extrusions cannot damage the wire insulation and cause a short.

I ran the X Carriage wires over the top cross member of the frame. I re-used one of the clear/white plastic wire mounts from the A8 and attached it to the wire holder block with an M3 screw and hex nut. Make sure the wires are well supported, but also have enough slack to allow free movement of the X and Y axis.

Level the Z Axis

To level the Z Axis, I recommend turning the Z Axis lead screws by hand until the Z Axis is all the way at the top and bumping against the rod holders. This will ensure your Z Axis is level. Now with the printer on, manually move the Z Axis down through the controller interface (Do NOT HOME). The Z Endstop mount should be loose to allow you to manually adjust its position.

Move the Z Axis down until the print head is very close, but not touching the bed. Once the nozzle is within a millimeter or two of the bed, move the Z Endstop up until it clicks from touching the Z Axis, then tighten the Z Endstop mount in its current position.

Once the Z Endstop mount is tightened, move the Z Axis up and down with the controller and ensure you are happy with its homing position (The nozzle is close to the bed without crashing into it). When you are happy, home all of the

axis, and level the bed with the leveling screws like you normally would on the Anet A8.

Firmware

My controller board was still using the stock Anet A8 firmware. After completing this frame rebuild, I found that my printer was capable of printing at much faster speeds, and the acceleration and jerk settings of the stock firmware caused significant corner bulging.

I recommend downloading and installing the latest version of the Skynet firmware, which is a version of Marlin modified to support the Anet Board. This will allow you to modify the firmware settings to better fit your printer.